

SCHNITT A-A

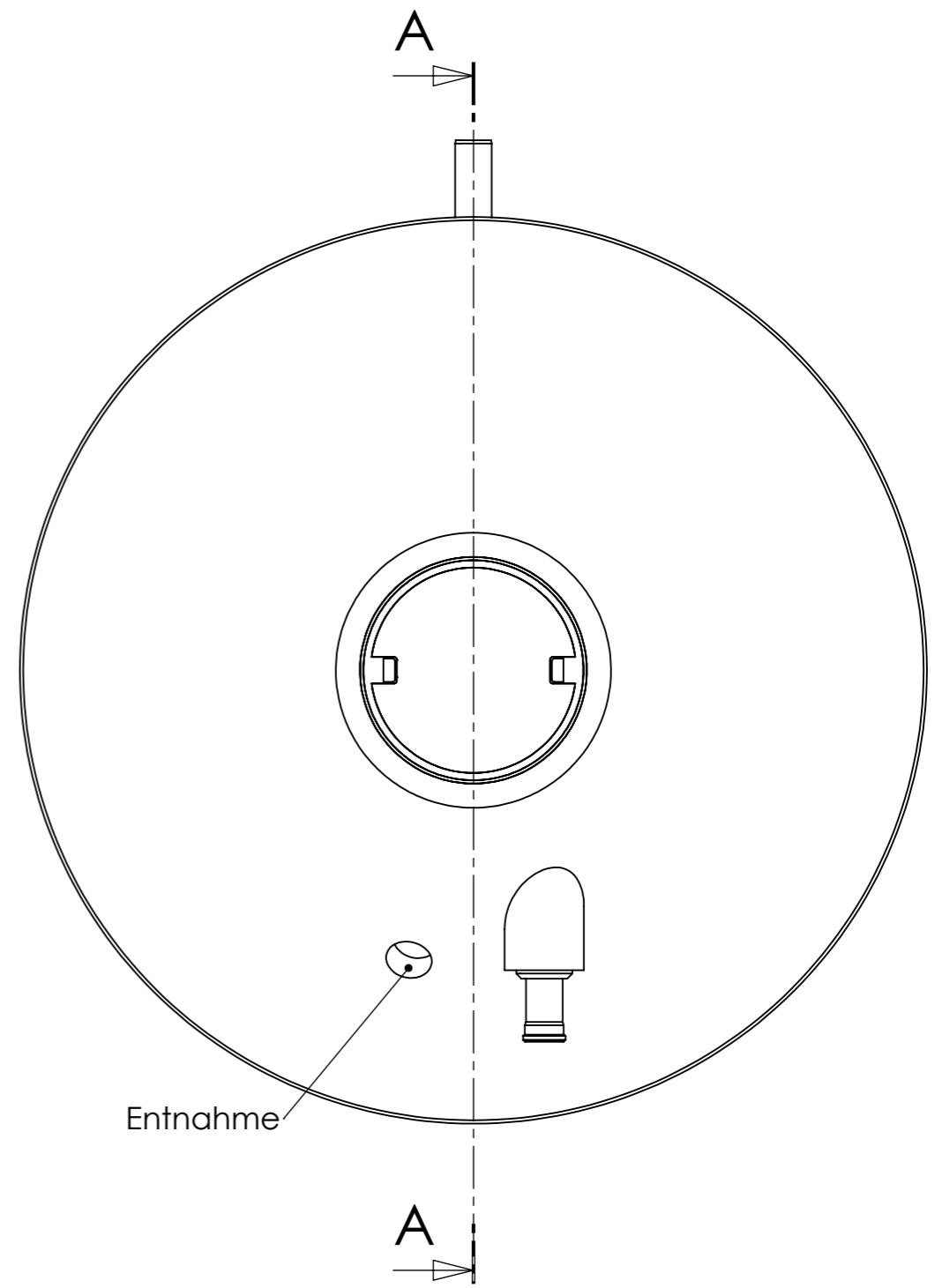

	NAME	UNTERSCHRIFT	DATUM	MENGE
Gezeichnet	Groß		28.04.2011	
Geprüft				



RZM80ZFDUO

A3

Maßstab: 1:20 Seite 1 von 1